

Pressure regulator U11



Pressure regulator
U11 F-40-10-0-M-M-0-NFG

Product features

- Diaphragm pressure regulator
- For non-corrosive industrial gases
- Single-stage with high control accuracy
- Central filter in the pressure regulator
- Safety pressure gauge acc. to DIN ISO 5171
- Pressure regulator with integrated relief valve
- Pressure regulator for oxygen with filter in inlet fitting
- Accessories like wall brackets and in-/outlet fittings are also available

Attention:

For the pressure regulator U11 special outlet fittings with orifice holes have to be used to ensure a correct function of the regulator.
see: data sheet "Fittings"

P „Performance“ for precise regulation

F „Flow“ for high flow rates

Technical data

Type	single-stage
Flow rate Q	max. 150 m ³ /h
Inlet pressure P₁	max. 40 bar
Outlet pressure P₂	max. 4 / 10 bar
Materials	
Body:	brass
Bonnet:	Alu, powder coated
Valve seat:	PA
Diaphragm:	NBR
In- and outlets	
Inlet:	G 1/2" female
Outlet:	G 1/2" female
Pressure gauge ports:	G 1/4" female
Outlet relief valve:	G 3/8" male
Temperature range	-30°C to +60°C
Leak rate	<10 ⁻³ mbar l/s He
Weight	ca. 2.5 kg

Performance factors and outlet pressures to find the flow rates of the pressure regulators U11

U11 series			
Type		P	F
Performance factor	L ₅ (5% pressure drop)	2,5	3
	L ₁₀ (10% pressure drop)	4	4,5
	L _{max}	5,5	6
max. outlet pressure P ₂ bar]	at 40 bar inlet pressure	4	10
Outlet pressure variations [%] relating to inlet pressure variation		2	2

Pressure regulator U11

spectro tec

Dimensions and connections

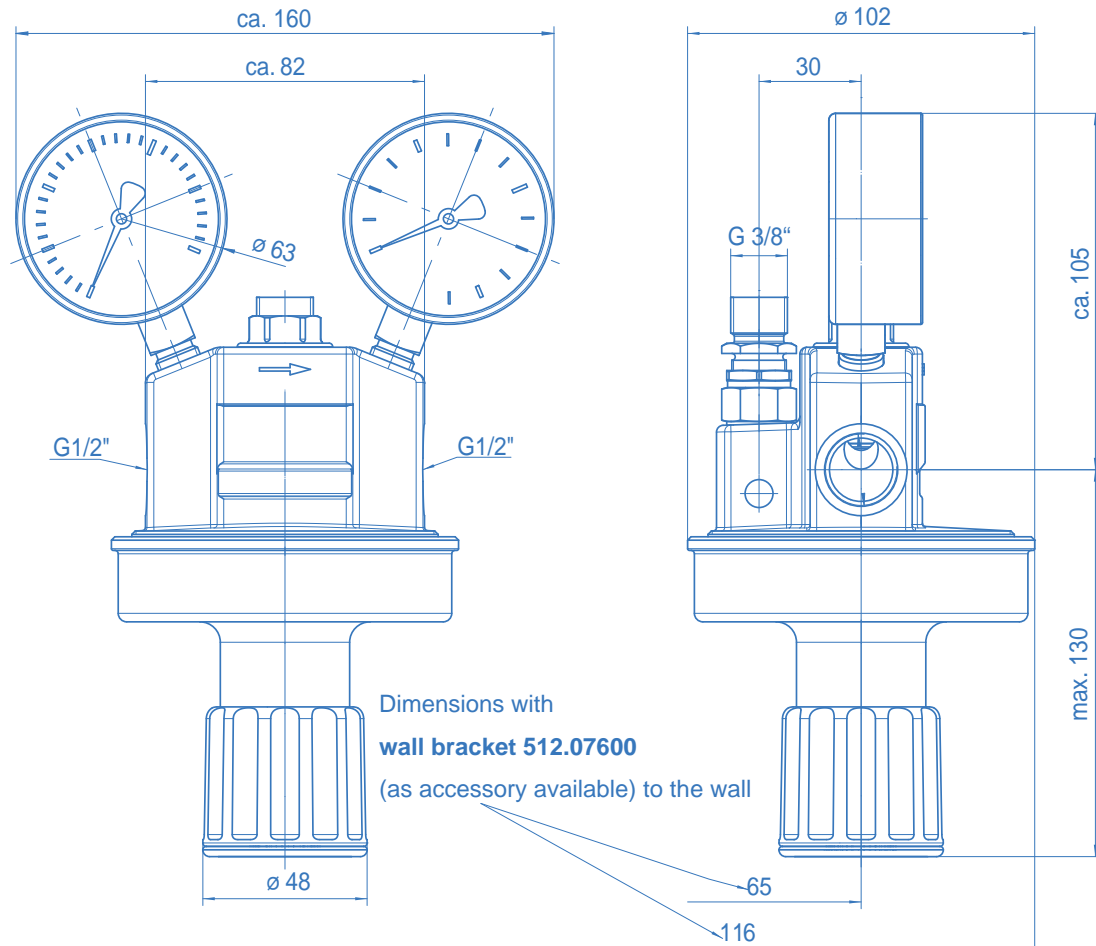

Ordering information: Pressure regulator U11

U11 P - 40 - 4 - 0 - M - M - 0 - NFG

In- and outlet-fittings:
see data sheet "Fittings"

Type

See table "Performance factors ..."
on page 1

Type of gas

NFG non flammable gases
FG flammable gases
O2 oxygen

Inlet pressure P_1

40 max. 40 bar

Outlet pressure P_2

1,5 max. 1,5 bar
2,5 max. 2,5 bar
4 max. 4 bar
6 max. 6 bar
10 max. 10 bar